



BN PRODUCTS-USA, LLC.

3450 Sabin Brown Road • Wickenburg, Arizona 85390
(800) 992-3833 • (928) 684-2813 • www.bnproducts.com

Bends and Cuts with Less Effort The MBC-16B1 Manual Rebar Bender/Cutter

This tool has a long two-piece handle and a cam mechanism that provides the correct radius bend for rebars up to #5 (5/8"). This tool has great leverage when cutting and bending grade 60 rebar. It features an adjustable 2-1/2" (63.5mm) diameter bending roller and replaceable cutting jaws that incorporate two open slots with innovative shaped blades to prevent chipping. The sturdy frame design is firmly mounted on a 2" x 8" x 44" wooden board and is ready to use. Other features include a comfortable long no-slip handle grip and a lifting chain and ring to make it easier to carry to and from the job site.



Model No.	MBC-16B1
Cutting Capacity	#5 (5/8") (16 mm) rebar grade 60 (420 MPa)
Bending Capacity	#5 (5/8") (16 mm) rebar grade 60 (420 MPa)
Bending Capability	0 - 180°
Replacement Jaw Set	#MBC-16RJS - Weight: 7 lbs. (3.2 kg)
Shipping Weight	53 lbs. (24 kg) with wood board
Overall Dimensions	57" L x 7.5" W x 10" H (with handle)
Warranty	6 months (includes parts and labor)

Bending procedure: a perfect 90° in one shot and a 180° in two.

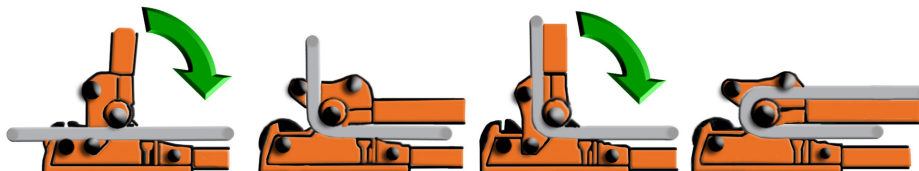

Products that make money, save money and add value to your bottom line



BN PRODUCTS-USA, LLC.

3450 Sabin Brown Road • Wickenburg, Arizona 85390

(800) 992-3833 • (928) 684-2813 • www.bnproducts.com



The MBC-16B1 Manual Rebar Bender/Cutter Parts Breakdown Information (The Wooden Mounting Board is Included)

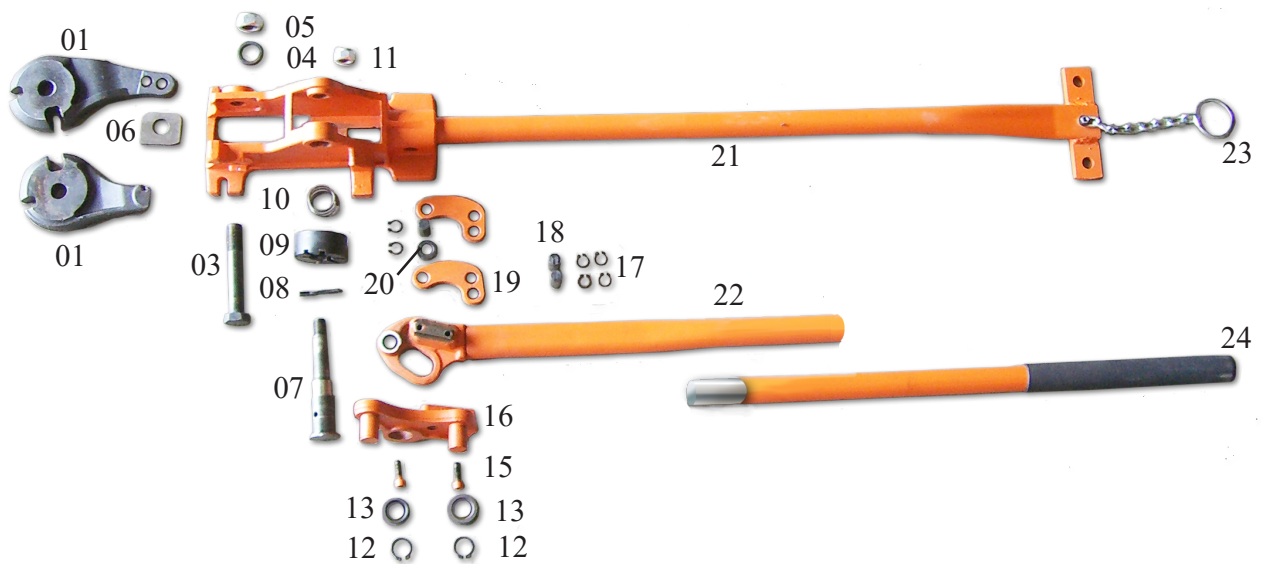

01	MBC16RJS	Movable Blades
03	MBC16-03	Blade Center Bolt
04	MBC16-04	Center Bolt Washer
05	MBC16-05	Center Bolt Lock Nut
06	MBC16-06	Spacer Plate
07	MBC16-07	Bender Shaft
08	MBC16-08	Roll Pin
09	MBC16-09	Bender Cam
10	MBC16-10	Cam Spring
11	MBC16-11	Bender Shaft Lock Nut
12	MBC16-12	Snap Ring – Roller Shaft (2)
13	MBC16-13	Large Bending Rollers (2)

15	MBC16-15	Hex Head Bolt (2)
16	MBC16-16	Bender Bracket
17	MBC16-17	Snap Ring – Inner Pin (6)
18	MBC16-18	Inner Pin (3)
18	MBC16-19	Lever Plate (2)
20	MBC16-20	Inner Roller
21	MBC16-21	Main Frame
22	MBC16B1P-22	Handle (Lower Piece)
23	MBC16-23	Chain & Ring
24	MBC16B1P-RH	Replacement Handle
27	MBC16-27	Handle Clips (2)

Products that make money, save money and add value to your bottom line



BN PRODUCTS-USA, LLC.

3450 Sabin Brown Road • Wickenburg, Arizona 85390

(800) 992-3833 • (928) 684-2813 • www.bnproducts.com

Manual Rebar Bender/Cutter Comparison Information BN Products-USA, Jet, Hit, Tolman Tools



BN Products-USA, LLC.
Part # MBC-16BI
Bending roller dia.: 2.5"



JET Equipment and Tools
Part # RCB-16NDLX
Bending roller dia.: 1.6"



HIT Tools USA
Part # 22-RC16B-3
Bending Roller Dia.: 1.6"



Tolman Tool
Part # Open Cutter/Bender
Bending Roller Dia.: 2.5"

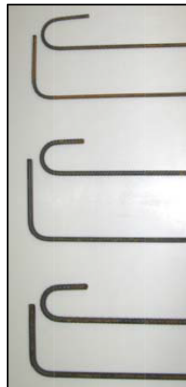

#5	90 degree bend	YES
#5	180 degree bend	YES
#4	90 degree bend	YES
#4	180 degree bend	YES
#3	90 degree bend	YES
#3	180 degree bend	YES

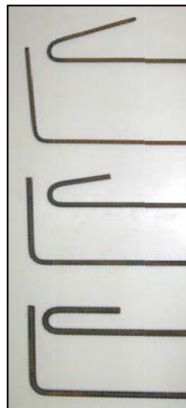

#5	90 degree bend	YES
#5	180 degree bend	YES
#4	90 degree bend	YES
#4	180 degree bend	NO
#3	90 degree bend	NO
#3	180 degree bend	NO

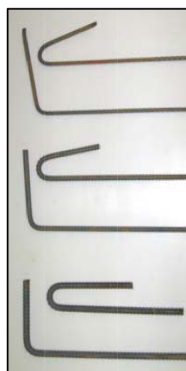

#5	90 degree bend	YES
#5	180 degree bend	YES
#4	90 degree bend	NO
#4	180 degree bend	NO
#3	90 degree bend	NO
#3	180 degree bend	NO

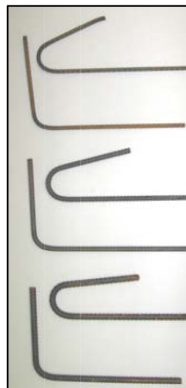

#5	90 degree bend	YES
#5	180 degree bend	NO
#4	90 degree bend	YES
#4	180 degree bend	NO
#3	90 degree bend	NO
#3	180 degree bend	NO

Above are actual pictures of bends done with (4) manufacturers of manual rebar benders/cutters. If the unit was able to produce a full 90 degree bend with one complete swing of the handle or a full 180 degree bend with two complete swings of the handle then it has "Yes" next to the rebar size. If the unit fell short of the required bend it has "NO" next to the rebar size. Test performed on 07/09/09. Benner-Nawman, Inc.

Products that make money, save money and add value to your bottom line



BN PRODUCTS-USA, LLC.

3450 Sabin Brown Road • Wickenburg, Arizona 85390
(800) 992-3833 • (928) 684-2813 • www.bnproducts.com

How to use adjustable bending roller:



Get true 90 and 180 degree bends.

The adjustable bending roller is marked with numbers for selecting the correct bending slot position on three different sizes of rebar. Simply pull out and turn the spring mounted adjustable bending roller to choose the following sizes:

16 meaning 16 mm or #5 (5/8") rebar
13 meaning 13 mm or #4 (1/2") rebar
10 meaning 10 mm or #3 (3/8") rebar

Stamped number should be in the 12 o'clock position.

How to bend 90 and 180 degree bends:

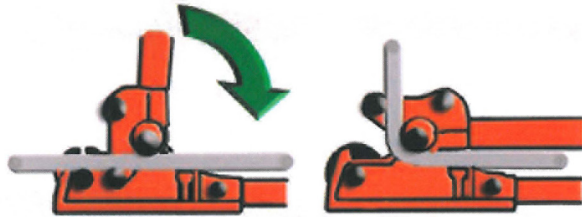

Position the rebar as shown to produce a 90 degree bend with one pull down of the handle.

Maximum Capacity Grade 60 Rebar.



To produce a 180 degree bend, repositioning the 90 degree bent rebar as shown and pull down the handle.

How to cut different sizes of rebar:



The top cutting slot is designed for cutting both #5 (5/8") and #4 (1/2") rebar. Simply put handle in the forward upward position and place rebar for desired cut.

Work Safely, avoid Personal Injury.

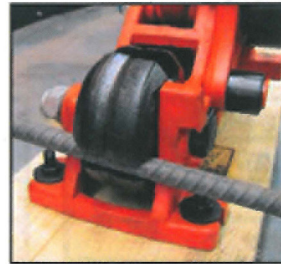

The bottom cutting slot is designed for cutting both #4 (1/2") and #3 (3/8") rebar. Simply put handle in the forward upward position and place rebar for desired cut. Make sure the rebar is fully placed into the cutting slots.

Important Safety Notes:

Bending and cutting rebar requires physical strength and coordination, please carefully position your feet and body firmly to avoid any slipping or body injuries. Use your body weight and the units leverage to minimize the effort to bend and cut. Keep body parts away from bending and cutting moving parts.

How to maintain your manual unit:

Remember to periodically lubricate all moving parts. Replacement parts including cutting jaws set are available (see parts breakdown on opposite page). Keep unit clean, be careful not to allow any dirt, dust or other contaminants to build on moving parts. The MBC-16B1 comes mounted on a wooden board because it much easier to bend and cut rebar on a stable platform. If wooden board needs replacement, we recommend replacing it with another 2" x 8" x 44" wooden board available from any lumber store.

Warranted against Defects for 6 Months.

Products that make money, save money and add value to your bottom line