



**ULTRA QUIET & OIL FREE**  
**AIR COMPRESSOR**  
**OWNER'S MANUAL**

**CALIFORNIA AIR TOOLS**  
**20040SPCAD**

**4.0 HP**  
**20 GALLON**  
**SOUND PROOF CABINET**  
**220 VOLTS 60 HERTZ**

## TABLE OF CONTENTS

INTRODUCTION	2
IMPORTANT SAFETY INSTRUCTIONS	5
AIR COMPRESSOR COMPONENTS	7
PRE-OPERATION CHECKLIST	8
Package Contents & Assembly	8
Inspect for Damage	8
Save Packaging	8
Compressor Location	8
Electrical Power	9
OPERATING THE AIR COMPRESSOR	9
Introduction	9
Assembly	9
Test Run & Break-in Period	10
Daily Operation	10
MAINTENANCE	11
Draining the Air Tank & Air Dryer	11
Changing the Air Filter	11
Testing for Leaks	11
Cleaning	11
STORAGE	11
TROUBLESHOOTING	12
SPECIFICATIONS	13
Electrical Circuit	13
Air Passage Drawing	13
WARRANTY	14
PRODUCT REGISTRATION	16

## INTRODUCTION

### **WARNING**

This manual contains important instructions for operating this product. For your safety, and the safety of others, be sure to read this manual thoroughly before operating the product.

Failure to properly follow all the instructions and precautions can cause you and others to be seriously hurt or killed.

Thank you for purchasing a California Air Tools, Inc. Air Compressor.

Record the model and serial numbers indicated on your air compressor's nameplate:

Model No. \_\_\_\_\_

Serial No. \_\_\_\_\_

Date of Purchase: \_\_\_\_\_

Store/Dealer: \_\_\_\_\_

## How to find a local service center:

Even quality built equipment might need service or repair parts. Contact the California Air Tools Customer Service Department:

Phone: 1-866-409-4581

Online: WWW.CALIFORNIAAIRTOOLS.COM

## Please provide the information below:

Model number and Serial number and specifications shown on the Model number/Serial number plate.

Part number or numbers shown in the parts list section of the owner's manual for your air compressor model.

A brief description of the trouble with the air compressor.

**Do not return your air compressor for service or parts to the store/dealer where purchased.**

## IMPORTANT SAFETY INSTRUCTIONS

### Safety Messages & Signal Words:

### **⚠ DANGER**

Indicates an immediate hazardous situation which, if not avoided, will result in death or serious injury to the operator or to bystanders.

### **⚠ WARNING**

Indicates a potentially hazardous situation which, if not avoided, could result in death or serious injury to the operator or to bystanders.

### **⚠ CAUTION**

Indicates a potentially hazardous situation which, if not avoided, may result in moderate or minor injury to the operator or to bystanders.

### **NOTICE**

Indicates a situation which, if not avoided, may result in damage to product components or other property.

### **⚠ DANGER**



#### RISK OF CUTTING

Moving parts can cause severe trauma.

Keep hands and feet away from rotating parts, tie up long hair, remove jewelry, and **DO NOT** wear loose clothing.

### **⚠ DANGER**



#### SHOCK

There is a danger of electric shock.

Use only undamaged electrical cords.

**DO NOT** touch bare wires or receptacles.

**DO NOT** operate air compressor in wet weather or in wet conditions.

**DO NOT** touch air compressor or cords if hands or feet are wet.

Ensure that all cords are free of damage before connecting to the power supply.

Ensure that you have a sufficient electrical supply for supporting the requirements of the motor.

Improper installation of the grounding plug is able to result in a risk of electric shock. When repair or replacement of the cord or plug is required, do not connect the grounding wire to either flat terminal. The wire with insulation having an outer surface that is green with or without yellow stripes is the grounding wire.

This product must be grounded. In the event of an electrical short circuit, grounding reduces the risk of electrical shock by providing an escape wire for the electric current.

This product is equipped with a cord having a grounding wire with an appropriate grounding plug. The plug must be plugged into an outlet that is properly installed and grounded in accordance with the local codes and ordinances.

This product is for use on a nominal 220-V circuit and has a grounding plug similar to the plug illustrated in sketch A. Only connect the product to an outlet having the same configuration as the plug.

**Do not use an adapter with this product.**

## ⚠ WARNING



### RISK TO BREATHING

Dust or dust-like particulates caused by power-sanding, sawing, grinding, drilling or any other construction-like activities can contain contaminants that are harmful to breathe.

Always use your air compressor in a well-ventilated and clean area.

Never breathe the air that comes directly out of the air compressor or air hose. This air is not suitable for breathing.

Always wear approved safety equipment. When performing dust-creating activities, securely wear properly-fit face masks or respirators.

If you feel ill from breathing while operating your air compressor, stop and seek medical attention immediately.

## ⚠ WARNING



### FLYING OBJECTS

Flying objects can cause injury to the eyes, head and other parts of the body.

Air-powered equipment and power tools are capable of propelling items (metal chips, fasteners and particulates) at high speed into the air and could result in injury.

Always wear approved head and eye protection.

Never point the air stream at any part of your body, or at another person or animal.

When operating the air compressor, make sure all other people and animals maintain a safe distance.

Do not move the air compressor when the air tank is under pressure.

Never use the air hoses to pull or move the air compressor.

Keep the air compressor on a flat surface.

## ⚠ WARNING



### HOT SURFACE



### FIRE

Air compressor surfaces become hot during operation.

**DO NOT** touch hot surfaces, because they can cause severe burns.

Do not touch the air compressor's cylinder head. During operation, the cooling fins of the cylinder head and delivery pipe become hot.

Allow the air compressor to cool before touching it.

**DO NOT** place a storage cover on the unit during operation. Only place a cover on the air compressor after it has thoroughly cooled down.

## ⚠ WARNING



### EXPLOSION

Exercise caution when using pressurized air.

To prevent injury and for your general safety, only use high-pressure hoses, fittings and couplings designed for use with air compressors.

Inspect all hoses, fittings and couplings for leaks and wear. When leaks and wear are detected, stop use and replace those items immediately. Do not repair.

Never leave pressurized air in the air tank when performing maintenance.

Never leave the air compressor unattended with the power supply in use and the air hose connected.

## ⚠ WARNING



EXPLOSION

Improper care could lead to the air tank bursting or exploding.

Drain air tank daily or after each use to prevent moisture buildup in the air tank.

Rust can weaken the air tank and cause leaks or bursting. If rust is detected, replace tank immediately. Do not try to repair the air tank by welding, drilling or modifying it in any other way. These modifications can weaken the air tank and cause a hazardous condition.

If air tank develops a leak, replace the air tank immediately. Never repair, weld or make modifications to the air tank or its attachments.

Never make adjustments to the factory-set pressures.

Never exceed manufacturer's maximum-allowable pressure rating attachments.

Because of extreme heat, do not use plastic pipe or lead tin solder joints for a discharge line.

## ⚠ WARNING



EXPLOSION



FIRE

Use caution to minimize risk of fire or explosion.

It is normal for the air compressor motor and pressure switch to produce sparks while operating. If sparks come in contact with vapors from gasoline or solvents, they may ignite and cause a fire or explosion.

Abrasive tools such as grinders, drills and other tools are capable of making sparks that can ignite flammable materials.

Always operate the air compressor a safe distance away from flammable items. Use in well-ventilated areas.

Never exceed the maximum rated pressure.

## ⚠ CAUTION

THIS EQUIPMENT INCORPORATES PARTS, SUCH AS SNAP SWITCHES, RECEPTACLES AND THE LIKE THAT TEND TO PRODUCE ARCS OR SPARKS, THERE, WHEN LOCATED IN A GARAGE, IT SHOULD BE IN A ROOM OR ENCLOSURE PROVIDED FOR THE PURPOSE, OR SHOULD BE 18 IN (45.7 CM) OR MORE ABOVE THE FLOOR.

## ⚠ CAUTION

Use caution when using extension cords.

Use an extension cord which is no more than 25' (7.6 m) long and at least 14 gauge.

Using an excessively long or thin-wired extension cord will cause severe damage to the motor.

Use only a 3-wire extension cord that has a 3-blade grounding plug.

As undersized cord results in a drop in the line voltage and loss of power and overheating.

When in doubt, use a heavier gauge. The smaller the gauge the more current the cord can carry.

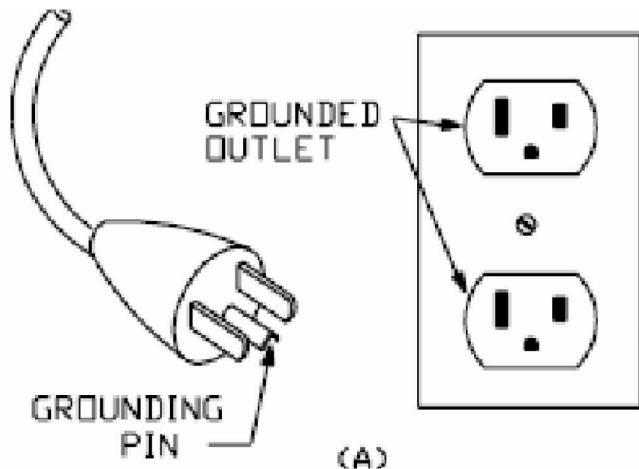

## LOCATIONS OF IMPORTANT LABELS

Read these important labels before operating.

These labels provide important safety and maintenance information. These labels should be considered as permanent parts of the air compressor. Should any of these labels become illegible, damaged or removed, please contact California Air Tools Customer Service department at 1-866-409-4581 for replacements.

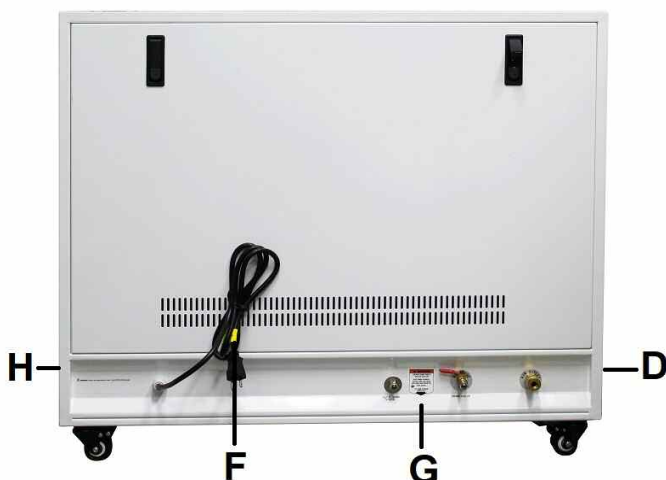

PRODUCT LABEL																													
A																													
B																													
C																													
D																													
E																													
F																													
G																													
H	<table border="1"> <thead> <tr> <th>⚠ WARNING</th> <th>⚠ ADVERTENCIA</th> <th>⚠ AVERTISSEMENT</th> </tr> </thead> <tbody> <tr> <td>READ MANUAL TO REDUCE THE RISK OF INJURY. SEE PARTS LIST AND INSTRUCTIONS FOR PROPER MANUAL OPERATION OF THE AIR COMPRESSOR.</td> <td>LEE EL MANUAL PARA REDUCIR EL RIESGO DE DAÑOS O LESIONES. LEER ENTENDER EL MANUAL DEL OPERADOR ANTES DE USAR EL PRESIÓN COMPRESOR DE AIRE.</td> <td>LIRE LE MANUEL POUR RÉDUIRE LE RISQUE DE BLESSURE. LIRE ET COMPRENDRE LES INSTRUCTIONS DE FONCTIONNEMENT DE LA COMPRESSEUR D'AIR.</td> </tr> <tr> <td>RISK OF PROTECTION HARNES TO COMPLY WITH ANSI Z39.1.</td> <td>RISGO DE LESIONES. NO OPERE CON PROTECTOR SIN CUMPLIR CON EL ESTANDAR ANSI Z39.1.</td> <td>RISQUE DE BLESSURE. NE PAS FONCTIONNER LE COMPRESSEUR SANS NE PAS RESPECTER LA NORME.</td> </tr> <tr> <td>RISK OF BURSTING. DO NOT DIRECT AIR STREAM AT BODY. DO NOT USE COMPRESSED AIR FOR BREATHING.</td> <td>RISGO DE EXPLOSION. NO DIRIGIR CORRIENTES DE AIRE HACIA EL CUERPO. NO USAR AIRE COMPRESOR PARA RESPIRAR.</td> <td>RISQUE DE BURSTING. NE PAS DIRIGER LE FLUX D'AIR VERS LE CORPS. NE PAS RESPIRER L'AIR COMPRESOR.</td> </tr> <tr> <td>RISK OF FIRE OR EXPLOSION. DO NOT SPRAY FLAMMABLE LIQUIDS OR A COMBUSTIBLE SOLID. DO NOT SPRAY FLAMMABLE LIQUIDS OR SOLID MATERIALS. SPRAYING FLAMMABLE LIQUIDS OR SOLID MATERIALS CAN CAUSE FIRE OR EXPLOSION. ALWAYS WEAR USE A SPARK-ARRESTING FILTER. TO REDUCE THE RISK OF INJURY AND KEEP THE COMPRESSOR OFF UNTIL THE AIR IS COOL AND THE PRESSURE IS RELEASED.</td> <td>RISGO DE INCENDIO O EXPLOSION. NO PULVERIZAR LÍQUIDOS VOLÁTILES NI SÓLIDOS COMBUSTIBLES. NO PULVERIZAR LÍQUIDOS VOLÁTILES NI MATERIALES SÓLIDOS. PULVERIZAR LÍQUIDOS VOLÁTILES NI MATERIALES SÓLIDOS COMBUSTIBLES PUEDE CAUSAR UN INCENDIO O UNA EXPLOSION. SIEMPRE USAR UN FILTRO DE BARRERA DE LLAMAS PARA REDUCIR EL RIESGO DE LESIONES Y MANTENER EL COMPRESOR APAGADO HASTA QUE EL TANQUE SE HAYA ENFRIADO Y SE HA LIBERADO LA PRESIÓN.</td> <td>RISQUE DE INCENDIE OU EXPLOSION. NE PAS PULVERISER DE LIQUIDES VOLATILES NI MATERIALES SOLIDES COMBUSTIBLES. NE PAS PULVERISER DE LIQUIDES VOLATILES NI MATERIALES SOLIDES COMBUSTIBLES PEUT CAUSER UN INCENDIE OU UNE EXPLOSION. TOUJOURS PORTER UN FILTRE A BRASIER POUR REDUIRE LE RISQUE DE BLESSURE ET GARDER LE COMPRESSEUR ETEINT JUSQU'A CE QUE LE TANK SE SOIT ENFRIE ET LA PRESSION SOIT RELACHEE.</td> </tr> <tr> <td>RISK OF BURNING. DO NOT ALLOW TOOL OR PARTS TO HEAT TO THE POINT PRESSURE GREATER THAN MANUFACTURER'S PRESSURE OF ATTACHMENT TO THE TANK TO OVERHEAT.</td> <td>RISGO DE QUEMADURAS. NO DEJAR LAS HERRAMIENTAS O PARTES QUE SE CALIENTEN MÁS ALLA DEL PUNTO DE PRESIÓN DE LA MANEJA PARA EVITAR QUE SE SOBRECALENTEN.</td> <td>RISQUE DE BRULURE. NE PAS LAISSER LES Outils OU PARTIES SE CHAUFFER À LA PRESSION SUPÉRIEURE À LA PRESSION DE MONTAGE.</td> </tr> <tr> <td>TO REDUCE THE RISK OF ELECTRIC SHOCK, DO NOT EXPOSE TO RAIN, CONDENSED MOISTURE.</td> <td>PARA REDUCIR EL RIESGO DE DESCARGA ELÉCTRICA, NO EXPOSER ALA LUPA A LA LLUVIA, HUMEDAD O CONDENSACIONES DE AGUA.</td> <td>POUR RÉDUIRE LE RISQUE D'ÉLECTROCUTION, NE PAS EXPOSER L'APPAREIL À LA PLUIE, À L'HUMIDITÉ OU À LA CONDENSATION D'EAU.</td> </tr> <tr> <td>RISK OF ELECTRICAL SHOCK. ALWAYS DISCONNECT TIGHTEN POWER SWAGE BEFORE SERVICING. COMPRESSOR MUST BE DE-ELECTRICATED.</td> <td>RISGO DE CHOC ELECTRICO. SIEMPRE DESCONECTAR Y APRIAR EL INTERRUPTOR DE ENERGIA ANTES DE SERVICIOS. EL COMPRESOR DEBE DESCONECTARSE DE LA RED ELÉCTRICA.</td> <td>RISQUE D'ÉLECTROCUTION. TOUJOURS DÉCONNECTER ET DÉBRANCHER L'APPAREIL DE L'ALIMENTATION ÉLECTRIQUE AVANT TOUT TRAVAIL DE RÉPARATION. LE COMPRESSEUR DOIT ÊTRE DÉBRANCHÉ DE LA SOURCE.</td> </tr> <tr> <td>THIS EQUIPMENT INCORPORATES PARTS, SUCH AS SWAP PARTS, REPAIRS AND REPAIRS. ALWAYS CHECK FOR PROPERLY INSTALLED PARTS. WHEN USED IN A GARAGE, IT SHOULD BE IN A ROOM OR BUILDING PROVIDED FOR THE PURPOSE OF STORAGE IN THE CASE OF A FIRE OR EXPLOSION.</td> <td>ESTE EQUIPO INCORPORA PARTES COMO REEMPLAZOS, REPARACIONES Y REPARACIONES. SIEMPRE VERIFICAR SI LAS PARTES SE INSTALAN CORRECTAMENTE. SI SE USA EN UN GARAJE, DEBE USARSE EN UN EDIFICIO O EN UN LUGAR DISEÑADO PARA EL ALMACENAMIENTO Y EL USO DE ESTE EQUIPO EN CASO DE UN INCENDIO O EXPLOSION.</td> <td>CEST EQUIPEMENT COMPREND DES PIÉCES, TELS QUE DES REPARATIONS À CHANGER. TOUJOURS VÉRIFIER SI LES COMPOSANTS SONT BIEN INSTALLÉS. SI L'ÉQUIPEMENT EST UTILISÉ DANS UN GARAGE, IL DOIT ÊTRE STOCKÉ DANS UN BÂTIMENT DESTINÉ À CÉLUI-CI DANS LE CAS D'UN INCENDIE OU D'UNE EXPLOSION.</td> </tr> </tbody> </table>	⚠ WARNING	⚠ ADVERTENCIA	⚠ AVERTISSEMENT	READ MANUAL TO REDUCE THE RISK OF INJURY. SEE PARTS LIST AND INSTRUCTIONS FOR PROPER MANUAL OPERATION OF THE AIR COMPRESSOR.	LEE EL MANUAL PARA REDUCIR EL RIESGO DE DAÑOS O LESIONES. LEER ENTENDER EL MANUAL DEL OPERADOR ANTES DE USAR EL PRESIÓN COMPRESOR DE AIRE.	LIRE LE MANUEL POUR RÉDUIRE LE RISQUE DE BLESSURE. LIRE ET COMPRENDRE LES INSTRUCTIONS DE FONCTIONNEMENT DE LA COMPRESSEUR D'AIR.	RISK OF PROTECTION HARNES TO COMPLY WITH ANSI Z39.1.	RISGO DE LESIONES. NO OPERE CON PROTECTOR SIN CUMPLIR CON EL ESTANDAR ANSI Z39.1.	RISQUE DE BLESSURE. NE PAS FONCTIONNER LE COMPRESSEUR SANS NE PAS RESPECTER LA NORME.	RISK OF BURSTING. DO NOT DIRECT AIR STREAM AT BODY. DO NOT USE COMPRESSED AIR FOR BREATHING.	RISGO DE EXPLOSION. NO DIRIGIR CORRIENTES DE AIRE HACIA EL CUERPO. NO USAR AIRE COMPRESOR PARA RESPIRAR.	RISQUE DE BURSTING. NE PAS DIRIGER LE FLUX D'AIR VERS LE CORPS. NE PAS RESPIRER L'AIR COMPRESOR.	RISK OF FIRE OR EXPLOSION. DO NOT SPRAY FLAMMABLE LIQUIDS OR A COMBUSTIBLE SOLID. DO NOT SPRAY FLAMMABLE LIQUIDS OR SOLID MATERIALS. SPRAYING FLAMMABLE LIQUIDS OR SOLID MATERIALS CAN CAUSE FIRE OR EXPLOSION. ALWAYS WEAR USE A SPARK-ARRESTING FILTER. TO REDUCE THE RISK OF INJURY AND KEEP THE COMPRESSOR OFF UNTIL THE AIR IS COOL AND THE PRESSURE IS RELEASED.	RISGO DE INCENDIO O EXPLOSION. NO PULVERIZAR LÍQUIDOS VOLÁTILES NI SÓLIDOS COMBUSTIBLES. NO PULVERIZAR LÍQUIDOS VOLÁTILES NI MATERIALES SÓLIDOS. PULVERIZAR LÍQUIDOS VOLÁTILES NI MATERIALES SÓLIDOS COMBUSTIBLES PUEDE CAUSAR UN INCENDIO O UNA EXPLOSION. SIEMPRE USAR UN FILTRO DE BARRERA DE LLAMAS PARA REDUCIR EL RIESGO DE LESIONES Y MANTENER EL COMPRESOR APAGADO HASTA QUE EL TANQUE SE HAYA ENFRIADO Y SE HA LIBERADO LA PRESIÓN.	RISQUE DE INCENDIE OU EXPLOSION. NE PAS PULVERISER DE LIQUIDES VOLATILES NI MATERIALES SOLIDES COMBUSTIBLES. NE PAS PULVERISER DE LIQUIDES VOLATILES NI MATERIALES SOLIDES COMBUSTIBLES PEUT CAUSER UN INCENDIE OU UNE EXPLOSION. TOUJOURS PORTER UN FILTRE A BRASIER POUR REDUIRE LE RISQUE DE BLESSURE ET GARDER LE COMPRESSEUR ETEINT JUSQU'A CE QUE LE TANK SE SOIT ENFRIE ET LA PRESSION SOIT RELACHEE.	RISK OF BURNING. DO NOT ALLOW TOOL OR PARTS TO HEAT TO THE POINT PRESSURE GREATER THAN MANUFACTURER'S PRESSURE OF ATTACHMENT TO THE TANK TO OVERHEAT.	RISGO DE QUEMADURAS. NO DEJAR LAS HERRAMIENTAS O PARTES QUE SE CALIENTEN MÁS ALLA DEL PUNTO DE PRESIÓN DE LA MANEJA PARA EVITAR QUE SE SOBRECALENTEN.	RISQUE DE BRULURE. NE PAS LAISSER LES Outils OU PARTIES SE CHAUFFER À LA PRESSION SUPÉRIEURE À LA PRESSION DE MONTAGE.	TO REDUCE THE RISK OF ELECTRIC SHOCK, DO NOT EXPOSE TO RAIN, CONDENSED MOISTURE.	PARA REDUCIR EL RIESGO DE DESCARGA ELÉCTRICA, NO EXPOSER ALA LUPA A LA LLUVIA, HUMEDAD O CONDENSACIONES DE AGUA.	POUR RÉDUIRE LE RISQUE D'ÉLECTROCUTION, NE PAS EXPOSER L'APPAREIL À LA PLUIE, À L'HUMIDITÉ OU À LA CONDENSATION D'EAU.	RISK OF ELECTRICAL SHOCK. ALWAYS DISCONNECT TIGHTEN POWER SWAGE BEFORE SERVICING. COMPRESSOR MUST BE DE-ELECTRICATED.	RISGO DE CHOC ELECTRICO. SIEMPRE DESCONECTAR Y APRIAR EL INTERRUPTOR DE ENERGIA ANTES DE SERVICIOS. EL COMPRESOR DEBE DESCONECTARSE DE LA RED ELÉCTRICA.	RISQUE D'ÉLECTROCUTION. TOUJOURS DÉCONNECTER ET DÉBRANCHER L'APPAREIL DE L'ALIMENTATION ÉLECTRIQUE AVANT TOUT TRAVAIL DE RÉPARATION. LE COMPRESSEUR DOIT ÊTRE DÉBRANCHÉ DE LA SOURCE.	THIS EQUIPMENT INCORPORATES PARTS, SUCH AS SWAP PARTS, REPAIRS AND REPAIRS. ALWAYS CHECK FOR PROPERLY INSTALLED PARTS. WHEN USED IN A GARAGE, IT SHOULD BE IN A ROOM OR BUILDING PROVIDED FOR THE PURPOSE OF STORAGE IN THE CASE OF A FIRE OR EXPLOSION.	ESTE EQUIPO INCORPORA PARTES COMO REEMPLAZOS, REPARACIONES Y REPARACIONES. SIEMPRE VERIFICAR SI LAS PARTES SE INSTALAN CORRECTAMENTE. SI SE USA EN UN GARAJE, DEBE USARSE EN UN EDIFICIO O EN UN LUGAR DISEÑADO PARA EL ALMACENAMIENTO Y EL USO DE ESTE EQUIPO EN CASO DE UN INCENDIO O EXPLOSION.	CEST EQUIPEMENT COMPREND DES PIÉCES, TELS QUE DES REPARATIONS À CHANGER. TOUJOURS VÉRIFIER SI LES COMPOSANTS SONT BIEN INSTALLÉS. SI L'ÉQUIPEMENT EST UTILISÉ DANS UN GARAGE, IL DOIT ÊTRE STOCKÉ DANS UN BÂTIMENT DESTINÉ À CÉLUI-CI DANS LE CAS D'UN INCENDIE OU D'UNE EXPLOSION.	
⚠ WARNING	⚠ ADVERTENCIA	⚠ AVERTISSEMENT																											
READ MANUAL TO REDUCE THE RISK OF INJURY. SEE PARTS LIST AND INSTRUCTIONS FOR PROPER MANUAL OPERATION OF THE AIR COMPRESSOR.	LEE EL MANUAL PARA REDUCIR EL RIESGO DE DAÑOS O LESIONES. LEER ENTENDER EL MANUAL DEL OPERADOR ANTES DE USAR EL PRESIÓN COMPRESOR DE AIRE.	LIRE LE MANUEL POUR RÉDUIRE LE RISQUE DE BLESSURE. LIRE ET COMPRENDRE LES INSTRUCTIONS DE FONCTIONNEMENT DE LA COMPRESSEUR D'AIR.																											
RISK OF PROTECTION HARNES TO COMPLY WITH ANSI Z39.1.	RISGO DE LESIONES. NO OPERE CON PROTECTOR SIN CUMPLIR CON EL ESTANDAR ANSI Z39.1.	RISQUE DE BLESSURE. NE PAS FONCTIONNER LE COMPRESSEUR SANS NE PAS RESPECTER LA NORME.																											
RISK OF BURSTING. DO NOT DIRECT AIR STREAM AT BODY. DO NOT USE COMPRESSED AIR FOR BREATHING.	RISGO DE EXPLOSION. NO DIRIGIR CORRIENTES DE AIRE HACIA EL CUERPO. NO USAR AIRE COMPRESOR PARA RESPIRAR.	RISQUE DE BURSTING. NE PAS DIRIGER LE FLUX D'AIR VERS LE CORPS. NE PAS RESPIRER L'AIR COMPRESOR.																											
RISK OF FIRE OR EXPLOSION. DO NOT SPRAY FLAMMABLE LIQUIDS OR A COMBUSTIBLE SOLID. DO NOT SPRAY FLAMMABLE LIQUIDS OR SOLID MATERIALS. SPRAYING FLAMMABLE LIQUIDS OR SOLID MATERIALS CAN CAUSE FIRE OR EXPLOSION. ALWAYS WEAR USE A SPARK-ARRESTING FILTER. TO REDUCE THE RISK OF INJURY AND KEEP THE COMPRESSOR OFF UNTIL THE AIR IS COOL AND THE PRESSURE IS RELEASED.	RISGO DE INCENDIO O EXPLOSION. NO PULVERIZAR LÍQUIDOS VOLÁTILES NI SÓLIDOS COMBUSTIBLES. NO PULVERIZAR LÍQUIDOS VOLÁTILES NI MATERIALES SÓLIDOS. PULVERIZAR LÍQUIDOS VOLÁTILES NI MATERIALES SÓLIDOS COMBUSTIBLES PUEDE CAUSAR UN INCENDIO O UNA EXPLOSION. SIEMPRE USAR UN FILTRO DE BARRERA DE LLAMAS PARA REDUCIR EL RIESGO DE LESIONES Y MANTENER EL COMPRESOR APAGADO HASTA QUE EL TANQUE SE HAYA ENFRIADO Y SE HA LIBERADO LA PRESIÓN.	RISQUE DE INCENDIE OU EXPLOSION. NE PAS PULVERISER DE LIQUIDES VOLATILES NI MATERIALES SOLIDES COMBUSTIBLES. NE PAS PULVERISER DE LIQUIDES VOLATILES NI MATERIALES SOLIDES COMBUSTIBLES PEUT CAUSER UN INCENDIE OU UNE EXPLOSION. TOUJOURS PORTER UN FILTRE A BRASIER POUR REDUIRE LE RISQUE DE BLESSURE ET GARDER LE COMPRESSEUR ETEINT JUSQU'A CE QUE LE TANK SE SOIT ENFRIE ET LA PRESSION SOIT RELACHEE.																											
RISK OF BURNING. DO NOT ALLOW TOOL OR PARTS TO HEAT TO THE POINT PRESSURE GREATER THAN MANUFACTURER'S PRESSURE OF ATTACHMENT TO THE TANK TO OVERHEAT.	RISGO DE QUEMADURAS. NO DEJAR LAS HERRAMIENTAS O PARTES QUE SE CALIENTEN MÁS ALLA DEL PUNTO DE PRESIÓN DE LA MANEJA PARA EVITAR QUE SE SOBRECALENTEN.	RISQUE DE BRULURE. NE PAS LAISSER LES Outils OU PARTIES SE CHAUFFER À LA PRESSION SUPÉRIEURE À LA PRESSION DE MONTAGE.																											
TO REDUCE THE RISK OF ELECTRIC SHOCK, DO NOT EXPOSE TO RAIN, CONDENSED MOISTURE.	PARA REDUCIR EL RIESGO DE DESCARGA ELÉCTRICA, NO EXPOSER ALA LUPA A LA LLUVIA, HUMEDAD O CONDENSACIONES DE AGUA.	POUR RÉDUIRE LE RISQUE D'ÉLECTROCUTION, NE PAS EXPOSER L'APPAREIL À LA PLUIE, À L'HUMIDITÉ OU À LA CONDENSATION D'EAU.																											
RISK OF ELECTRICAL SHOCK. ALWAYS DISCONNECT TIGHTEN POWER SWAGE BEFORE SERVICING. COMPRESSOR MUST BE DE-ELECTRICATED.	RISGO DE CHOC ELECTRICO. SIEMPRE DESCONECTAR Y APRIAR EL INTERRUPTOR DE ENERGIA ANTES DE SERVICIOS. EL COMPRESOR DEBE DESCONECTARSE DE LA RED ELÉCTRICA.	RISQUE D'ÉLECTROCUTION. TOUJOURS DÉCONNECTER ET DÉBRANCHER L'APPAREIL DE L'ALIMENTATION ÉLECTRIQUE AVANT TOUT TRAVAIL DE RÉPARATION. LE COMPRESSEUR DOIT ÊTRE DÉBRANCHÉ DE LA SOURCE.																											
THIS EQUIPMENT INCORPORATES PARTS, SUCH AS SWAP PARTS, REPAIRS AND REPAIRS. ALWAYS CHECK FOR PROPERLY INSTALLED PARTS. WHEN USED IN A GARAGE, IT SHOULD BE IN A ROOM OR BUILDING PROVIDED FOR THE PURPOSE OF STORAGE IN THE CASE OF A FIRE OR EXPLOSION.	ESTE EQUIPO INCORPORA PARTES COMO REEMPLAZOS, REPARACIONES Y REPARACIONES. SIEMPRE VERIFICAR SI LAS PARTES SE INSTALAN CORRECTAMENTE. SI SE USA EN UN GARAJE, DEBE USARSE EN UN EDIFICIO O EN UN LUGAR DISEÑADO PARA EL ALMACENAMIENTO Y EL USO DE ESTE EQUIPO EN CASO DE UN INCENDIO O EXPLOSION.	CEST EQUIPEMENT COMPREND DES PIÉCES, TELS QUE DES REPARATIONS À CHANGER. TOUJOURS VÉRIFIER SI LES COMPOSANTS SONT BIEN INSTALLÉS. SI L'ÉQUIPEMENT EST UTILISÉ DANS UN GARAGE, IL DOIT ÊTRE STOCKÉ DANS UN BÂTIMENT DESTINÉ À CÉLUI-CI DANS LE CAS D'UN INCENDIE OU D'UNE EXPLOSION.																											



# AIR COMPRESSOR

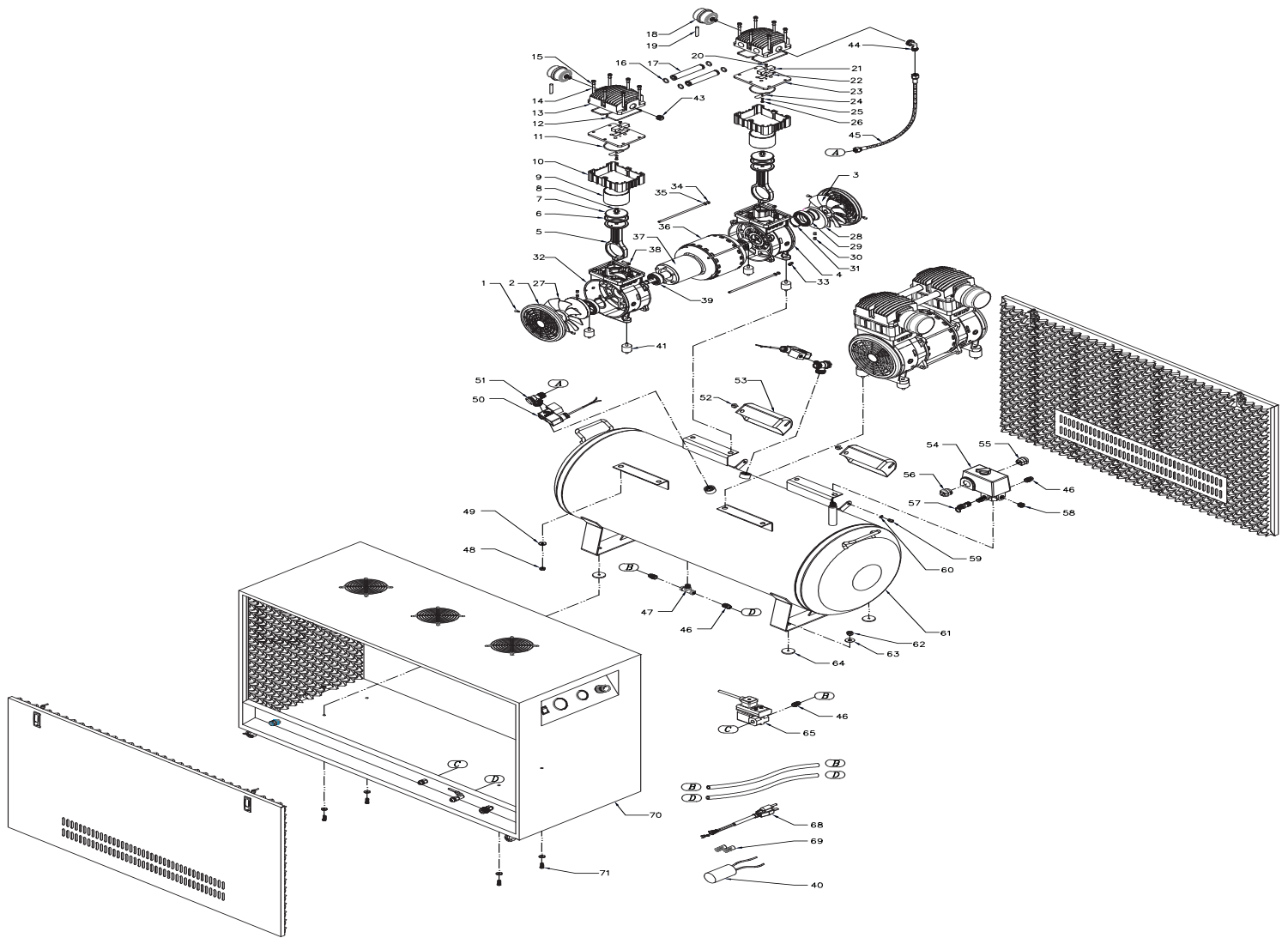

NO.	Part	NO.	Part	NO.	Part	NO.	Part	NO.	Part
1	Fan Screw	21	Limited Block	41	Motor Mount	61	20 Gallons Tank	81	
2	Fan Cover	22	Gassing Valve	42	Protector	62	Nut	82	
3	Left Fan	23	Valve Plate	43	Opressor Allen	63	Flat Washer	83	
4	Left Crank Case	24	Air Inflow Valve	44	Elbow	64	Cushion Foot	84	
5	Connecting Rod	25	Metal Strengthen Sheet	45	Flow Hose	65	Auto Drain Valve	85	
6	Piston Ring	26	Screw	46	Straight Adapter	66	Hose	86	
7	Pressure Plate	27	Right Fan	47	T Connector	67	Hose	87	
8	Pressure Plate Screw	28	Crank	48	Lock Nut	68	Power Cord	88	
9	Cylinder	29	Bearing	49	Flat Washer	69	Wire Connector	89	
10	Adjustment Stent	30	Opressor Allen	50	Solenoid Valve	70	Sound Proof Cabinet	90	
11	Cylinder Obturating Ring	31	Retaining Ring	51	Valve Check	71	Screw	91	
12	Cylinder Head Obturating Ring	32	Right Crank Case	52	Snap-in cord Grip	72		92	
13	Cylinder Head	33	Washer	53	Capacitor Cover	73		93	
14	Cylinder Head Screw	34	Motor Screw	54	Pressure Switch	74		94	
15	Washer Split Lock	35	Flat Washer	55	Strain Relief	75		95	
16	Connecting Hose Obturating	36	Stator	56	Strain Relief	76		96	
17	Connecting Hose	37	Rotor	57	Safety Valve	77		97	
18	Air Filter	38	Cheese Head Screw	58	Opressor Allen	78		98	
19	Air Filter Tube	39	Bearing	59	Socket Cap Screw	79		99	
20	Limited Block Screw	40	Capacitor	60	Washer	80		100	

## PRE-OPERATION CHECKLIST

### Package Contents

**Model: 20040SPCAD**

**Package contents:**

- \* Air Filters (4)
- \* 3' Tubing (for auto drain valve)
- \* Owner's Manual

**Install the Air Filters.**

1. Screw the four air filters into the 4 ports located on the top left and right sides of the motor heads.

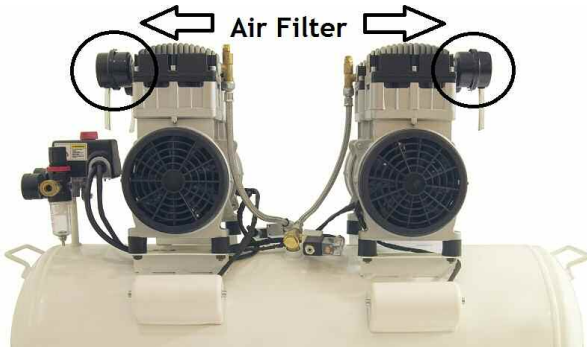

**! WARNING**



**EXPLOSION**



**FIRE**

**Use caution to minimize risk of fire or explosion.**

**It is normal for the air compressor motor and pressure switch to produce sparks while operating. If sparks come in contact with vapors from gasoline or solvents, they may ignite and cause a fire or explosion.**

**Abrasive tools such as grinders, drills and other tools are capable of making sparks that can ignite flammable materials.**

**Always operate the air compressor a safe distance away from flammable items. Use in well-ventilated areas.**

**Never exceed the maximum rated pressure.**

### Inspect for Damage

Before using the air compressor, make sure the air tank is not damaged, inspect all parts for damage, and check that all pipes are firmly connected.

Do not use the air compressor if any damage is found. If damaged, have an authorized service center inspect and test the air compressor to ensure that is working properly.

### Save Packaging

Save all outside packaging in case you ever need to return the product for service or repair.

**! WARNING**



**RISK TO BREATHING**

**Dust or dust-like particulates caused by power-sanding, sawing, grinding, drilling or any other construction-like activities can contain contaminants that are harmful to breathe.**

**Always use your air compressor in a well-ventilated and clean area.**

**Never breathe the air that comes directly out of the air compressor or air hose. This air is not suitable for breathing.**

**Always wear approved safety equipment. When performing dust-creating activities, securely wear properly-fit face masks or respirators.**

**If you feel ill from breathing while operating your air compressor, stop and seek medical attention immediately.**

### Compressor Location

#### Use on Flat Surface

For proper operation, the air compressor must be placed on a flat surface with an incline no greater than 15 degrees.

#### Maintain a Clear Area

It is very important that the air compressor is positioned so that there is adequate airflow around the machine. There must be at least 2 feet of obstacle-free space surrounding and above the air compressor.

#### Use in Areas with Clean Air

For proper operation and to maximize the longevity of the air compressor, it is very important that the air drawn into the air compressor is clean. The air compressor should not be used in areas where dust or particulates are in the air. This will damage the motor and impair proper operation.

**IMPORTANT:** Always use the air filter, properly installed.



## Electrical Power

### Electrical Power Requirements

#### **⚠ DANGER**



SHOCK

There is a danger of electric shock.

Use only undamaged electrical cords.

**DO NOT** touch bare wires or receptacles.

**DO NOT** operate air compressor in wet weather or in wet conditions.

**DO NOT** touch air compressor or cords if hands or feet are wet.

Ensure that all cords are free of damage before connecting to the power supply.

Ensure that you have a sufficient electrical supply for supporting the requirements of the motor.

Improper installation of the grounding plug is able to result in a risk of electric shock. When repair or replacement of the cord or plug is required, do not connect the grounding wire to either flat terminal. The wire with insulation having an outer surface that is green with or without yellow stripes is the grounding wire.

This product must be grounded. In the event of an electrical short circuit, grounding reduces the risk of electrical shock by providing an escape wire for the electric current.

This product is equipped with a cord having a grounding wire with an appropriate grounding plug. The plug must be plugged into an outlet that is properly installed and grounded in accordance with the local codes and ordinances.

This product is for use on a nominal 220-V circuit and has a grounding plug similar to the plug illustrated in sketch A. Only connect the product to an outlet having the same configuration as the plug.

Do not use an adapter with this product.

Before using the air compressor, refer to the serial label for voltage and amperage requirements. Make sure you have a sufficient electrical supply for supporting the motor's requirements.

Use a dedicated 220 Volt 60 Hertz circuit

Low voltage and/or an overload circuit can cause the motor's overload protection system circuit breaker to trip.

Contact a electrician for help.

#### **⚠ CAUTION**

Use caution when using extension cords.

Use an extension cord which is no more than 25' (7.6 m) long and at least 14 gauge.

Using an excessively long or thin-wired extension cord will cause severe damage to the motor.

Use only a 3-wire extension cord that has a 3-blade grounding plug.

As undersized cord results in a drop in the line voltage and loss of power and overheating.

When in doubt, use a heavier gauge. The smaller the gauge the more current the cord can carry.

### Electrical Extension Cord

Inspect all electrical extension cords to ensure that they are free of damage

When using an extension cord, use a heavy-duty cord that is no more than 25 feet long and at least 14 gauge.

Use only a 3-wire extension cord that has a 3-blade grounding plug.

## OPERATING THE AIR COMPRESSOR

Save this manual for future reference.

### Introduction

#### **⚠ WARNING**

This manual contains important instructions for operating this product. For your safety, and the safety of others, be sure to read this manual thoroughly before operating the product.

Failure to properly follow all the instructions and precautions can cause you and others to be seriously hurt or killed.

This air compressor features a compact structure, stable, performance, a high airflow rate, easy operation and low maintenance. Because the air compressor produces no oil in the airflow, it can be used for air supplies that need oil-free air. The motor directly drives the pistons and does not need any lubrication or oil to function for a long period of time.

### Assembly

1. Attach the air hose to a 1/4" Universal/Industrial Male Quick Connector. Attach the air hose to the air compressor.
2. Install the (4) air filters into the 4 ports located on the top right and left of the motor heads.
3. Make sure the "manual" drain valve is in the off position and that the air compressor power switch is in the OFF position
4. Ensure that the power supply you are going to use is operating normally. Use a dedicated ( 220 Volts 60 Hertz) outlet.
5. Insert the power supply cord into the power supply socket.

## Test Run

Before using the air compressor for the first time, complete a test run as follows:

1. Turn the power switch to the OFF position. Plug the power supply cord into a power supply socket. Start the air compressor by turning the power switch to the ON position. The pressure gauge reading will slowly rise as pressure increases inside the air tank. When the gauge reading reaches 120 -125 PSI, the pressure switch will automatically turn the power off. This indicates the compressor is working normally.
2. Turn the power switch to the Off position, unplug the power supply cord and release the air from the manual drain valve.

At this point proceed to the next step (daily operations) starting the air compressor to continue to use.

**Note:** If the Air Compressor is not working properly, the pressure gauge will indicate that there is a decrease in pressure in the air tank. If there is an air leak from the compressor the pressure in the air tank decreases, the pressure switch resets and the motor automatically turns back on.

If you detect an air leakage, turn the power switch to the Off position, release the air from the tank by pulling on the safety valve. Unplug the power supply cord and contact Customer Support for Assistance.

## ! WARNING



### FLYING OBJECTS

**Flying objects can cause injury to the eyes, head and other parts of the body.**

**Air-powered equipment and power tools are capable of propelling items (metal chips, fasteners and particulates) at high speed into the air and could result in injury.**

**Always wear approved head and eye protection.**

**Never point the air stream at any part of your body, or at another person or animal.**

**When operating the air compressor, make sure all other people and animals maintain a safe distance.**

**Do not move the air compressor when the air tank is under pressure.**

**Never use the air hoses to pull or move the air compressor.**

**Keep the air compressor on a flat surface.**

## ! WARNING



### HOT SURFACE



### FIRE

**Air compressor surfaces become hot during operation.**

**DO NOT touch hot surfaces, because they can cause severe burns.**

**Do not touch the air compressor's cylinder head. During operation, the cooling fins of the cylinder head and delivery pipe become hot.**

**Allow the air compressor to cool before touching it.**

**DO NOT place a storage cover on the unit during operation. Only place a cover on the air compressor after it has thoroughly cooled down.**

## Daily Operation

### Starting the compressor:

1. Turn the power switch to the OFF position.
2. Attach the air hose to a 1/4" Industrial Male Quick Connector. Attach hose to the Female Connector on the Air Compressor
3. Close the manual drain valve.
4. Plug the power supply cord into a power supply socket.
5. Turn the power switch to the ON position.
6. Let the motor run and tank fill until motor turns off.
7. Operate air tool normally.
8. To regulate the air to the air hose. have the air compressor and air tool both turned on and running. Turn the regulator knob to the right to increase the pressure and to left to decrease the air pressure to the hose and air tool..  
Do not use continuously (running) for more than (1) hour.

### Shutting down the compressor:

1. Turn the power switch to the OFF position.
2. Unplug the power supply cord.
3. Reduce the pressure in the air tank through the air hose.
4. Draining the air tank daily from the manual drain valve will help prevent corrosion in the air tank.

## MAINTENANCE

### Draining the Air Tank

The frequency at which you should drain the air tank depends on the environmental conditions and the amount of operating time logged.

Your air compressor is equipped with an EZ-1 Auto Drain Valve that automatically drains the air tank.

1. Place the drain tube from the auto drain valve into a waste container capable of holding water.
2. The Auto Drain Valve will open at the beginning of a cycle to drain the water out of the air tank.
3. Empty the waste container of water regularly.
4. **Highly recommended to manually drain the air tank regularly from the ball drain valve to remove excess water.**
5. Draining the air tank protects parts from rust and corrosion.

### Changing the Air Filter

The air filters are designed to reduce noise and help prevent particulates in the air from entering and damaging the air compressor.

After being used for a period of time, the air filter will become clogged. This will reduce the air intake capabilities of the air compressor, reducing performance. Therefore, the air filter must be replaced regularly.

1. Open the lid of the air filter and remove the old air filter element.
2. Replace with a new air filter element and close the lid.

### Testing for Leaks

Make sure all connections are tight. Do not overtighten.

A small leak in any hose or pipe connection will reduce the air compressor's performance.

To test for small leaks, spray a small amount of soapy water on the area suspected of leaking. If the soap bubbles, replace the broken part.

### Cleaning

Clean items with a soft brush, or wipe with a moistened cloth using a biodegradable solvent.

Do not use flammable liquids such as gasoline or alcohol. Always keep parts clean from dirt and dust for better performance.

## STORAGE

Before storing for a prolonged period of time:

1. Turn off the power supply.
2. Disconnect the power cord from the power supply.
3. Release all of the pressure and moisture from the air tank through the manual drain valve.
4. Clean the air compressor to remove all dirt and dust.
5. Cover the air compressor with a cover to protect the unit from dust and moisture.
6. Do not stack or store any items on top of or around the air compressor. Damage could occur.

### CAUTION

**TO REDUCE THE RISK OF ELECTRIC SHOCK,  
DO NOT EXPOSE TO RAIN.**

**STORE INDOORS.**

## TROUBLESHOOTING

PROBLEM	POSSIBLE CAUSE	POSSIBLE SOLUTIONS
Pressure drop in the tank.	Air leaks at connections.	Let the compressor build pressure in the tank, to the maximum pressure if possible. Brush soapy water on air connections and look carefully for air bubbles. Tighten leaky connections. If the problem persists, contact the seller for further advice.
The solenoid valve leaks when the compressor is idle.	Non-return valve seal is defective.	Let the air in the tank flow out until all the pressure is released. Then remove the non-return valve plug and clean the valve seal. If necessary, replace the seal and then reinstall all components.
The compressor stopped and does not start.	Overload cutout operated because of motor overheating.	Check that the main voltage corresponds to specifications. An extension cord that is too thin or too long can cause a voltage drop and cause the motor to overheat. Allow the motor to cool down. Press the Reset Button to restart the air compressor. Ensure that the compressor is plugged into a socket as close as possible to the consumer unit or fuse box.
	Motor windings are burned out.	Contact Customer Support.
The motor does not start and makes a humming noise.	Capacitor is burned out.	Replace starter capacitor.
The motor does not start or starts slowly.	Low voltage supply to the motor.	Check that the main voltage corresponds to specifications. An extension cord that is too thin or too long can cause a voltage drop and cause the motor to overheat. Allow the motor to cool down. Press the Reset Button to restart the air compressor. Ensure that the compressor is plugged into a socket as close as possible to the consumer unit or fuse box.
The compressor is noisy with metallic clangs.	Compressor head gasket broken or valve faulty.	Stop the compressor and contact the dealer.
The compressor does not reach the maximum pressure.	Compressor head gasket broken or valve faulty.	Stop the compressor and contact the dealer.
The compressor doesn't seem to provide as much air as it did when new and/or the compressor cuts off within a much shorter time period.	The pressure switch needs adjusting.	Stop the compressor and contact the dealer.
	The tank is full of water due to condensation.	Open the ball valve and release the pressure. Open the drain valve and release the water within the tank.
The motor pump unit does not stop when the tank pressure reaches its maximum working pressure (8 bar or 116 PSI) and the safety valve vents air.	Pressure switch defective or needs adjusting.	Stop the compressor immediately and contact Customer Support.

## SPECIFICATIONS

### Electrical Circuit

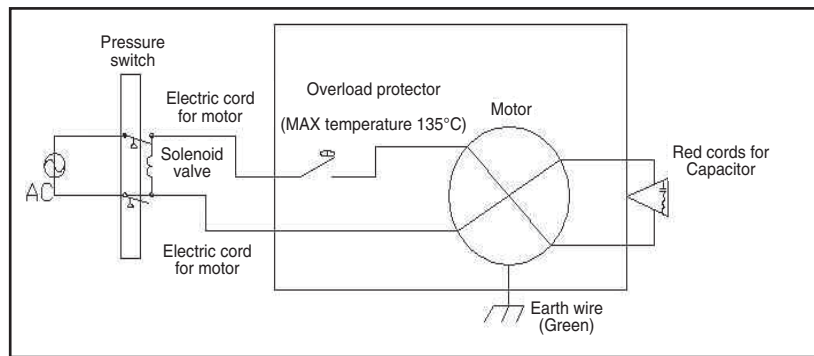

### Air Passage Drawing

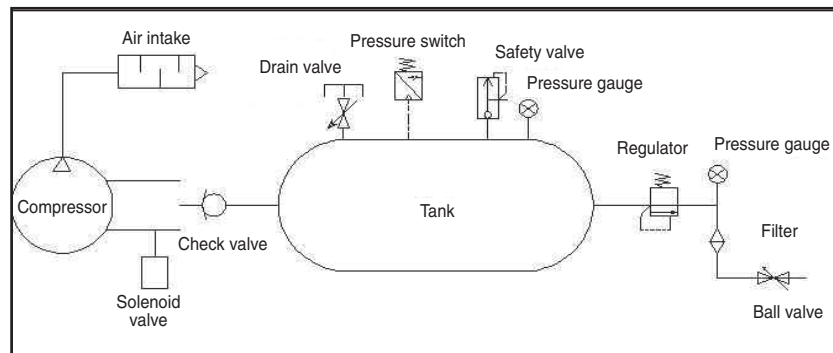



## CALIFORNIA AIR TOOLS INC. LIMITED WARRANTY

This warranty is limited to Air Compressors distributed by:

California Air Tools, Inc.  
8560 Siempre Viva Road  
San Diego, CA 92154

### Limited Warranty

California Air Tools Inc. will repair or replace, free of charge, to the original retail customer who purchased a California Air Tools, Inc. Air Compressor from an authorized dealer, distributor or distributor's dealer in North America.

This warranty does not transfer to subsequent owners.

California Air Tools Inc. will repair or replace, at its option, any parts of the portable air compressor that are proven by an authorized service center to be defective in material or workmanship under normal use during the applicable warranty time period as stated below. This limited warranty covers the cost of the replacement parts and labor for all defects when installed by an authorized service center. Transportation charges are the responsibility of the customer. Any part replaced under warranty becomes the property of California Air Tools Inc.

All parts replaced under warranty will be considered as part of original product, and any warranty on those parts will expire coincident with the original product warranty.

### Limited Warranty Periods

Non-commercial / Non-rental (personal use by a retail customer):	12 months parts and labor
Commercial / Rental (usage for income, business use):	12 months parts and labor

The limited warranty period begins on the date of retail purchase by the original purchaser.

### Disclaimers, Limitations of Remedies & Exclusions

This warranty gives you specific legal rights, and you may also have other rights which may vary from state to state.

#### Disclaimer of Other Warranties

To the fullest extent permitted by applicable law, this limited warranty is exclusive and expressly in lieu of any and all other warranties, including, without limitation, any implied warranties of merchantability or fitness for a particular purpose or any other implied warranties that may arise from the course of dealing or usage of the trade. California Air Tools Inc. hereby disclaims and excludes all other warranties. To the extent that California Air Tools Inc. products are consumer products under applicable federal and state law with respect to any customer, the duration of any implied warranties (including but not limited to implied warranties of merchantability or fitness for a particular purpose) are limited to the shortest duration permitted by applicable law or the Limited Warranty period provided herein, whichever is longer.

#### Limitations of Remedies

California Air Tools Inc. shall not be liable to customer, or anyone claiming under customer, for any other obligations or liabilities, including but not limited to, obligations or liabilities arising out of breach of contract or warranty, negligence or other tort or any theory of strict liability, with respect to the air compressor or California Air Tools Inc. acts or omissions or otherwise. To the fullest extent permitted by applicable law, California Air Tools Inc. shall not in any event be liable for incidental, compensatory, punitive, consequential, indirect, special or other damages, including but not limited to loss of use, loss of income, loss of time, loss of sales, injury to personal property, or liability customer incurs with respect to any other person, or any other type or form of consequential damage or economic loss.

## Exclusions

In addition to the foregoing disclaimers, limitations and terms, this limited warranty shall not apply to and does not cover accessories, nor does it cover products that are in any way subject to any of the following:

1. Improper setup, installation or storage.
2. Lack of proper maintenance and service.
3. Accident, damage, abuse or misuse.
4. Abnormal operating conditions or applications.
5. Repair or modification by customer or any third party without written consent of California Air Tools Inc.
6. Use under operating conditions or in applications not recommended by California Air Tools Inc.
7. Normal wear.
8. The use of accessories or attachments not recommended by California Air Tools Inc.
9. Repairs without California Air Tools prior written approval
10. Incorrect voltage, improperly wired or failure to have a certified licensed electrician install the air compressor.
11. Acts of God.

The application of these exclusions will be determined at the sole discretion of California Air Tools Inc.

## Registration

Warranty registration with California Air Tools Inc. is required on all products.

You can mail the enclosed registration form or complete on-line at [www.californiaairtools.com](http://www.californiaairtools.com) under Customer Service Tab.

Warranty is also available by keeping and showing your original receipt from the date of purchase to an Authorized California Air Tools Service Center.

## Service

Do not return your air compressor to the place of purchase.

Warranty is available by showing your original receipt with the date of purchase to an Authorized California Air Tools Service Center.

For all customer service inquiries.

Contact California Air Tools Customer Service

1-866-409-4581 M - F (8am - 4pm) Pacific Time

## WWW.CALIFORNIAAIRTOOLS.COM

Go to **Contact Us Tab**

**Click on the Parts or Service Tab for faster service.**

## PRODUCT REGISTRATION

To register your product, please complete the information below and mail to the mailing address at the end of this page.

### 1. Personal Information:

Full Name (Include Middle Initial): \_\_\_\_\_

Mailing Address: \_\_\_\_\_

City: \_\_\_\_\_ State: \_\_\_\_\_ Zip Code: \_\_\_\_\_

Phone Number: \_\_\_\_\_

E-mail Address: \_\_\_\_\_

(Check here to receive product information and offers via e-mail)

(Check here to receive product information from other companies via e-mail)

### 2. Product Information:

Date of Purchase: \_\_\_\_\_ (MM / DD / YYYY)

Model Number: \_\_\_\_\_

Serial Number: \_\_\_\_\_ (Found on name plate)

Purchased Location: \_\_\_\_\_

Purchase Price: \_\_\_\_\_

Type of Primary Use for this Product:    Home    Recreation    Emergency    Rental    Commercial

Other \_\_\_\_\_

Features Influencing Product Purchase:    Brand    Portability    Power Rating    Price    Warranty

Other Features (describe) \_\_\_\_\_

What other Power Equipment are you interested in purchasing in the future? \_\_\_\_\_

Thank you for registering your product.

Mail to:  
California Air Tools  
8560 Siempre Viva Road  
San Diego, CA 92154