

MODEL: BNH-1145 DEMOLITION HAMMER OPERATOR MANUAL

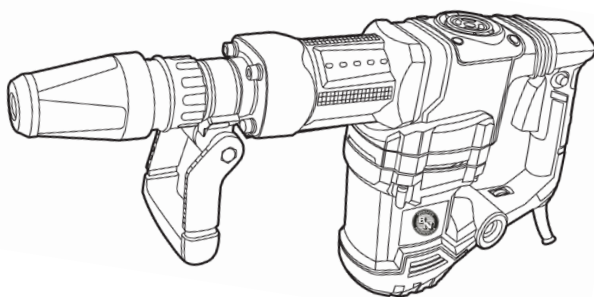

**Read this Operator Manual carefully
before operating this tool.**

This Manual includes important Tool Safety warnings. Failure to follow instructions may result in electrical shock, fire and/or serious personal injury. This power tool is intended for chiseling work in concrete, brick, masonry and asphalt, as well as for driving and compacting, when using corresponding and respective accessories. This tool should be used only for its prescribed purpose. Any other use is deemed to be a case of misuse.

3450 N. SABIN BROWN ROAD • WICKENBURG, AZ 85390
(800) 992-3833 • MAIL@BNPRODUCTS.COM

DEMOLITION HAMMER OPERATOR MANUAL

Thank you for choosing our BNH-1145 Demolition Hammer. This manual covers the proper operation and maintenance. Before operating, please read this manual carefully for important procedures and safety.

All technical data and drawings in this manual are consistent with manufacturing information on this product. However, as a result of revisions and ongoing improvements, the contents of this manual may vary slightly from the actual product. BN Products-USA, LLC. reserves the right to make revisions to the product and this manual at any time, without notice.

The copyright of this instruction manual belongs to BN Products-USA, LLC. No reproduction is allowed without the written consent of BN Products-USA, LLC. All rights reserved.

**This manual is a component of this tool
and should accompany the product if it is resold.**

WORK AREA SAFETY

Keep work area clean and well lit. Cluttered or dark areas invite accidents. Do not operate power tools in explosive environments, such as in the presence of flammable liquids, gases, or dust. This tool may create sparks which may ignite the dust or fumes.

Do not use the device in a wet environment (rain, snow, or standing water). Keep children and bystanders away while operating the machine.

ELECTRICAL SAFETY

Power tool plugs must match the outlet. Never modify the plug in any way. Do not use any adapter plugs with grounded power tools. Modified plugs and matching outlets will increase risk of electric shock.

Avoid bodily contact with grounded surfaces such as pipes, radiators, or similar fixtures. There is an increased risk of electric shock.

Do not expose power tools to rain or wet conditions. Moisture entering the motor enclosure will increase the risk of electric shock.

Do not use a damaged power cord. Never use the cord for carrying or pulling the power tool. Keep cord away from heat, oil, sharp edges or moving parts. Use only extension cords designed for the power demand of this tool. Outdoor extension cords should always be used.

PERSONAL SAFETY

Stay alert when operating a power tool. Do not use a power tool while you are tired or under the influence of drugs, alcohol or medication.

Avoid unintentional running of the tool. Ensure the switch is in the off-position before connecting to power source, lifting, or transporting the tool.

Remove any adjustment key or wrench before turning the power tool on. A wrench or a key left attached to a moving part of the power tool may result in personal injury.

Do not overreach. Keep proper footing and balance at all times. This enables better control of the power tool in unexpected situations.

Dress properly. Do not wear loose clothing or jewelry. Keep your hair, clothing and gloves away from moving parts. Loose clothes, jewelry or hair can be caught in moving parts.

If devices are provided for the connection of dust extraction and collection facilities, ensure these are connected and properly used. Use of these devices can reduce dust related hazards.

Use personal protective equipment. Always wear eye protection. Protective equipment such as dust mask, non-skid safety shoes, hard hat, or hearing protection used for appropriate conditions will reduce personal injuries.

POWER TOOL USE AND CARE

Do not force the tool beyond its capabilities. Use the correct power tool for your application. The correct power tool will do the job better and safer at the rate for which it was designed.

Do not use the power tool if the switch does not turn it on and off. Any power tool that cannot be controlled with the switch is dangerous and must be repaired. Store power tools out of the reach of children and do not allow persons unfamiliar with the tool or these instructions to operate the power tool. Power tools are dangerous in the hands of untrained users.

Perform periodic maintenance for all tools. Check for misalignment or binding of moving parts, breakage of parts and any other condition that may affect the power tool's operation. If damaged, have the power tool repaired before use.

Keep cutting tools sharp and clean. Properly maintained cutting tools with sharp cutting edges are less likely to bind and are easier to control.

Use the power tool, accessories and chisels, etc., in accordance with these instructions, taking into account the working conditions and the work to be performed. Use of the power tool for operations different from intended could result in a hazardous situation.

SERVICE

Have your power tool serviced by a qualified repair person using only genuine replacement parts. A parts guide is available for this tool at BNProducts.com. Contact BN Products-USA™ Customer Service at (800) 992-3833 if you need assistance from a qualified professional service department.

DEMOLITION HAMMER SAFETY

- Use both hands, one on each handle, at all times for proper stability and control of the demolition hammer.
- Wear a dust mask. Do not inhale particulate matter generated in demolition or chiseling operations.
- Before beginning work, always check the working area to ensure that no concealed electric cables or gas and water pipes are present.
- If the power cord is damaged, it must be replaced to avoid risk of electric shock.
- Do not touch the chisel during or immediately after operation. The contact surfaces may become very hot during operation and could cause serious injury or burns.
- Moderate operational time while using the Demolition Hammer to minimize risks related to vibration of the tool. If you lack sensation due to vibration or are fatigued, resume activity only after rest.
- Only use SDS-Max chisels, which are designed for this tool.
- Ensure that this tool has come to a complete and operational stop before touching the SDS-Max chuck, or attempting to change a chisel.
- A chisel must be firmly and correctly seated and secured in the SDS-Max chuck before beginning operation of the Demolition Hammer.

VIBRATION SAFETY

- Constant exposure to vibration has been known to cause serious health problems such as back pain, carpal tunnel syndrome, and vascular disorders.
- Include vibration-free periods during the work day.
- Avoid excessive gripping of the tool. The demolition hammer should be gripped as lightly as possible while still keeping full control.
- Do not “force” the tool with excessive force of your own. Let the tool do the work!

- Wear suitable gloves to reduce vibration effects.
- Use the lowest impact rate setting that is effective for the job.
- Follow all safety and operational instructions in this manual.

SPECIFICATIONS & ACCESSORIES INCLUDED

Description	1500W Demolition Hammer
Power	120W / 60Hz
Impact Power	45Joules / 33.2 ft. pounds
Impact Rate	900-2100 BPM
Chuck / Bit Lock	SDS Max
Unit Weight	24.3 lbs. (11 kg)
Accessories Included	(1) protective Case
	(1) Carbon Brush Kit
	(1) Lubricant Grease Tube
	(1) Ball Point Chisel (18 x 280mm)
	(1) 22mm Flat Chisel (18 x 280mm)
	(1) Auxiliary Handle
	(1) Operator's Manual

SETUP

Before using this tool, read the entire safety information section at the beginning of this manual.

To prevent serious injury from accidental operation: Turn the Power Switch off, and unplug the tool from any electrical outlet before making any adjustments to this machine.

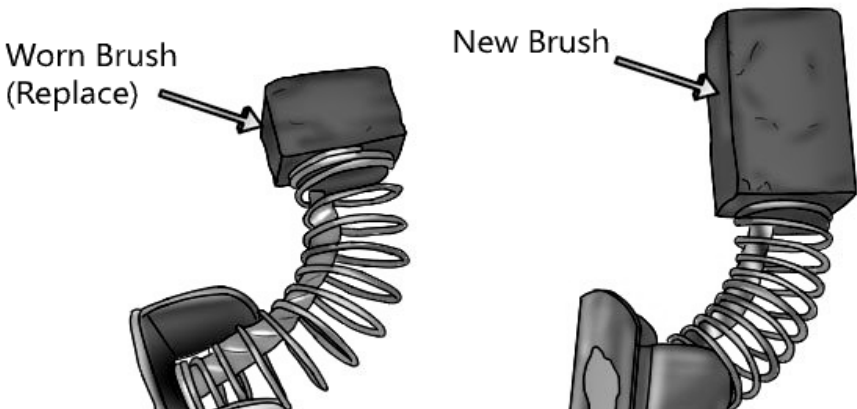

OPERATING INSTRUCTIONS



Use only accessories designed for this tool. Follow instructions that accompany all accessories. ONLY use SDS Max chisels with the BNH-1145 Demolition Hammer.



Use hearing protection and eye protection while operating this tool.



If any part is missing or damaged, do not use the demolition hammer; contact BN Customer Service for assistance.

AUXILLARY (FRONT) HANDLE

The auxiliary handle may be adjusted into any position around the shaft of the demolition hammer. To adjust the auxiliary handle, turn the handle adjustment knob counter-clockwise to loosen the handle. The handle may rotate around the shaft of the tool once it is loosened to the desired position. The adjustment knob should be firmly tightened (clockwise) once the handle is set in its desired position.



SDS MAX Chuck: Chisel Installation & Removal

This demolition hammer is designed to use only Chisels intended for use with an SDS Max chuck. The SDS Max chuck allows for accessories to be changed quickly and securely.

Installation

If necessary, clean the mounting end of the chisel; a very light application of grease may be used. Insert the bit into the SDS Max chuck housing while applying moderate pressure, rotating counter-clockwise. At the same time, slide the front of the chuck housing toward the main body of the tool. This will allow the bit to slide and lock into place when the chuck is released.

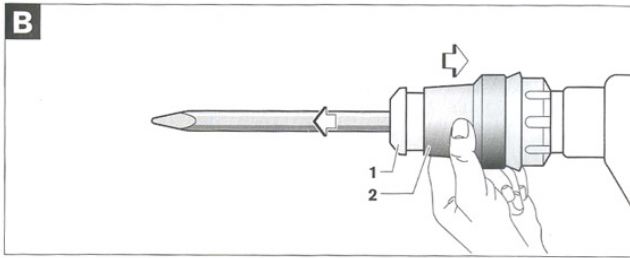
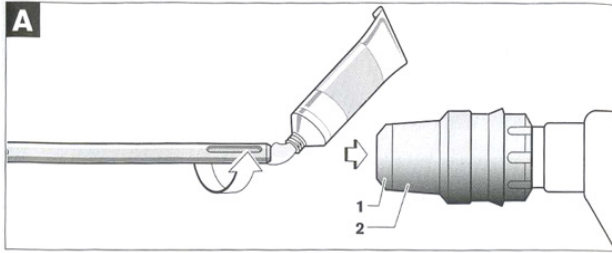

Slide the front of the chuck toward the body of the tool to insert, lock, and release an SDS Max bit

Chisel Removal

To remove a chisel from the SDS MAX chuck, push back the chuck cover in the direction of the main body of the tool. With the chuck pushed into the rear position, hold the chuck cover in place while sliding the chisel out of the SDS MAX chuck.

CAUTION: The chisel may become hot during use. Wear protective gloves when changing the chisel following use of this demolition hammer.

GENERAL OPERATING INSTRUCTIONS

Power Switch & Trigger Lock

Make sure that the trigger-style switch is in the OFF position, and that the trigger lock is not engaged (which would lock the trigger in the ON position).

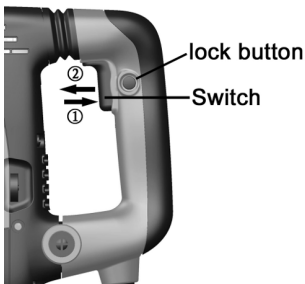

- The trigger-style switch starts the hammer; depressing the lock button will lock the trigger in the ON position.

- Releasing the trigger will stop the hammer; to release, make sure that the lock button is extended outward. If the lock button is engaged in the locked position, depress the trigger switch fully to release the trigger lock.

SPEED ADJUSTMENT

Setting the Impact Rate

The machine is equipped with electronic speed control. You can preselect the speed by adjusting the variable speed dial (Figure 5):



Variable Speed Setting	Impact Rate (BPM)
1	900
2	1100
3	1350
4	1600
5	1800
6	2100

12-Point Rotating Head (with variable lock)

The BNH-1145 demolition hammer is equipped with a 12-point rotating head, which allows a worker to set an optimal working angle for each application or use of the tool.

Insert the chisel into the SDS MAX chuck. Pull the SDS MAX chuck backward toward the main handle, and turn the chisel to the desired position using the rotating head ring. Release the SDS MAX chuck, slightly rotating the chisel until it latches into position to lock the chisel at the desired working angle.



MAINTENANCE AND INSPECTION

Inspecting the Tool

- Chisels must be in good condition and free of chips or damage. Chisels should be sharp. Worn or dull bits will underperform and overwork the rotary hammer motor. Replace dull chisels or damaged bits with new ones that are in good condition.
- Inspect the tool to make sure that there are no loose parts and that all mounting screws and fasteners are tight. Missing parts must always be replaced immediately before using the tool.
- It is important to store the tool in a cool dry place when not in use. Always keep the tool away from moisture and prevent water from entering the tool.
- Check for misalignment or binding of any moving parts when starting the tool at each use.
- Inspect the power cord for cracks or cuts each time the tool is used.
- Ensure that the tool does not have any parts that are cracked or broken parts prior to any use.
- Never use petroleum-based solvents, gasoline, paint thinners, or alcohol to clean this tool. A clean damp rag is recommended.
- This tool is shipped pre-lubricated. Due to the airtight construction of the tool, periodic lubrication is only necessary when replacing carbon brushes (see following section, Replacing Carbon Brushes)

Carbon Brush Replacement

Carbon Brush access: Remove 3 screws from base of the BNH-640 Rotary Hammer

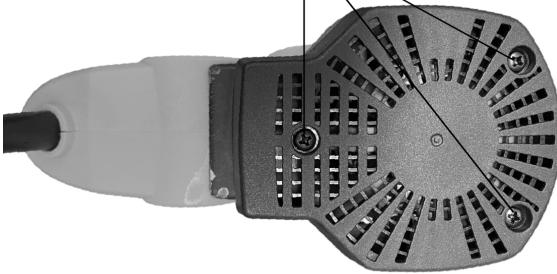

Carbon Brushes are subject to wear over time. Brushes should be inspected after every 100 hours of use. At least 1/4" of the wearable surface should remain for the tool to perform optimally.

To inspect and replace carbon brushes on the BNH-1145 Demolition Hammer: Disconnect power cord from any connected outlet. Turn the tool upside down.

The black fan cover at the base of the tool will need to be removed. Remove the three (3) Phillips screws from the fan cover at the bottom of the tool.

The two brushes are secured with a spring clip (coil spring) on each side of the tool (Figure 8). To remove, the clip should be moved using a small screwdriver. The wire lead can be pulled away from the wire lead connector to free each of the two carbon brushes.

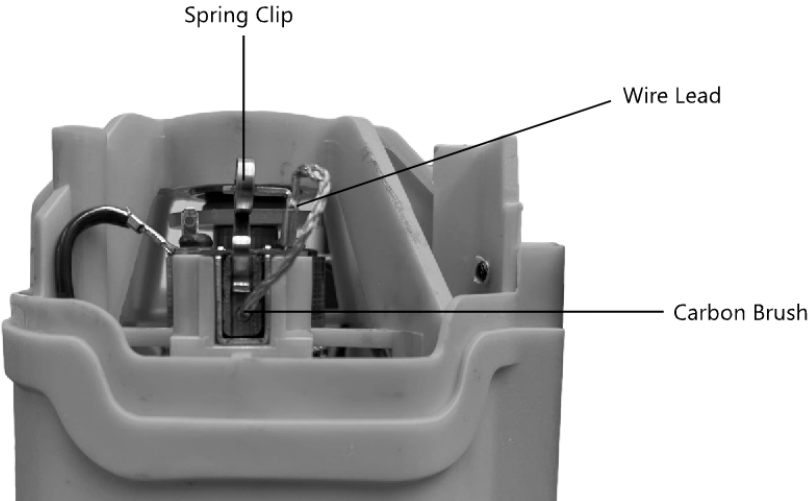

Inspect the brushes to determine if they should be replaced.

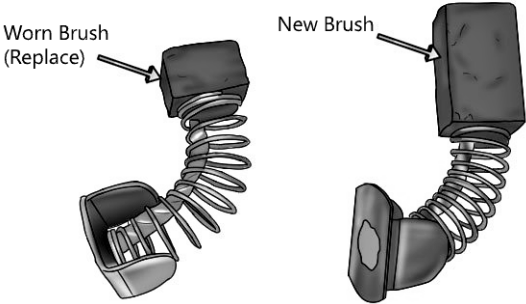

To re-install the brushes or replace with a new set, the brush should be inserted into the brush carrier subassembly, the lead wire connected, and the spring clip (coil spring) should be repositioned to firmly hold the brush into place. The wire lead must be reconnected to the wire lead connector.

These steps must be repeated on the tool's opposite side replace both carbon brushes. One spare set of brushes are included with the tool. Contact BN Products-USA™ Customer Service at (800) 992-3833 if you require assistance in purchasing additional replacement sets.

When the carbon brushes have been replaced, the gearbox should be lubricated. Using the wrench included with the demolition hammer, remove the lubrication port cap, (See page 7 of this manual).

Lubrication

- Add lubricant to the gearbox using the lubricant provided with the tool, or use recommended lubricant product **after every 80 hours of use**:

BN Products-USA Model #	Manufacturer	Lubricant Product ID	Quantity
BNH-1770	Mobil	SHC32	80g
BNH-1145	Mobil	SHC32	60g
BNH-640	Mobil	SHC32	50g
BNH-1770	Shell	DARINA R2	80g
BNH-1145	Shell	DARINA R2	60g
BNH-640	Shell	DARINA R2	50g

NOTICES

This tool is subject to enhancement and ongoing development. Parts, part numbers, design, and specifications may be changed on this product at any time, without prior notification.

ONE-YEAR LIMITED MANUFACTURER WARRANTY

BN Products-USA™ warrants each tool to the original purchaser to be free of defects in materials and workmanship under everyday and appropriate use and service for one year. Use the applicable QR code or web URL below to access our full One-Year Warranty policy and procedure, or to complete a Warranty Service Request for this product.

If you are requesting Warranty Service, it is recommended that you have your original purchase order available to upload or scan using a mobile device.

Questions with regard to our One-Year Limited Manufacturer Warranty may be directed to BN Products-USA™ Customer Service at (800) 992-3833.

SCAN 	ONE-YEAR LIMITED WARRANTY https://www.bnproducts.com/warranty-1/ 	REQUEST WARRANTY SERVICE ONLINE https://www.bnproducts.com/warranty-request/ 
		



BN Products-USA, LLC.

3450 North Sabin Brown Road
Wickenburg, AZ 85390

Customer Service: **(800) 992-3833**
Website: **www.BNProducts.com**